

Green Energy For All



Micro Inverter User's Manual

WVC-600
WVC-700
WVC-800



IoT intelligent monitoring system



About Micro Inverters

The system consists of an array of micro-inverters that convert direct current (DC) to alternating current (AC) and feed it into the public grid. The system is designed to install one micro-inverter for every two PV modules. Each micro-inverter works independently, ensuring that each PV module maximum power generation. This setup enables the user to directly control the efficiency of the individual PV module arrays, increasing the flexibility and availability of the system dependability.

About the manual

This manual contains important instructions for WVC-600/WVC-700/WVC800 micro inverters, which must be read completely before installing or debugging the equipment. For the sake of safety, only qualified technicians who have received professional training or have demonstrated competence can install and maintain this micro inverter under the guidance of this document.

Other information

Product information is subject to change without notice. This user manual will be updated frequently. Please contact sales for the latest version.

Manual catalog

1. Important Notes	04
1.1 Product Range	04
1.2 Target Users	04
1.3 Symbols Used	04
2. About safety	05
2.1 Important Safety Instructions	05
2.2 Symbol Description	06
2.3 Radio Interference Statement	06
3. About Products	07
3.1 About the 2-in-1 Product	07
3.2 Emphasis	07
3.3 Terminal Introduction	07
3.4 Dimensions (mm)	07
4. About the function	08
	08
5. About installation	09
5.1 Accessories	09
5.2 Installation Precautions	09
5.3 Required space distance	10
5.4 Grounding Considerations	10
5.5 Preparation	10
5.6 Installation Steps	11
6. Monitoring system	13
6.1 APP Installation Steps	13
6.2 Status LEDs	15
6.3 Insulation Resistance Detection	15
6.4 On-site Inspection (Qualified Installers Only)	16
6.5 Routine Maintenance	16
6.6 Micro Inverter Replacement	17
7. Retirement	18
7.1 Decommissioning	18
7.2 Storage And Transportation	18
7.3 Handling	18
8. Technical data	19
8.1 DC Input	19
8.2 AC Output	19
8.3 Efficiency, Safety and Protection	20
8.4 Mechanical Data	20
8.5 Features	20
8.6 Package	20

Appendix 1:	21
Instructions	21
Appendix 2:	22
Wiring Diagram - 230 VAC Single Phase:	22
Wiring Diagram - 230 VAC 3 Phase:	23
Wiring Diagram - 120 VAC / 240 VAC Split Phase:	24
Wiring Diagram - 120 VAC / 208 VAC 3 Phase:	25

1. Important Notes

1.1 Product Range

This manual introduces the assembly, installation, commissioning, maintenance and fault finding of the following types of micro inverters:

- WVC-600
- WVC-700
- WVC-800



*Note: "600" means 600W, "700" means 700W, "800" means 800W

1.2 Target users

For safety reasons, only qualified technicians who have received training or demonstrated competence should install and maintain this microinverter under the guidance of this document.

1.3 symbols used

The safety symbols in this user manual are shown below.

legend	illustrate
 DANGER	Indicates a hazardous situation that could result in a hazard of fatal electric shock, other serious bodily injury, or a fire hazard.
 WARNING	Instructions are instructions that must be fully understood and followed to avoid potential safety hazards, including equipment damage or personal injury.
 CAUTION	Indicates that the described action must not be performed. The reader should stop, use it with caution, and fully understand the operation described before proceeding.







2. About safety

2.1 Important Safety Instructions

WVC-600/WVC-700/WVC-800 micro inverters are designed and tested according to international safety requirements. But precautions must be taken when installing and operating this microinverter. The installer must read and follow all instructions, precautions and warnings in this installation manual.

<ul style="list-style-type: none">• All operations, including transport, installation, start-up and maintenance, must be carried out by qualified and trained personnel.
<ul style="list-style-type: none">• Before installation, inspect the equipment to ensure there is no shipping or handling damage that could affect insulation integrity or safety clearances. Choose the installation location carefully and adhere to the specified cooling requirements. Unauthorized removal of necessary protective devices, improper use, and incorrect installation and operation can result in serious safety and electric shock hazards or equipment damage.
<ul style="list-style-type: none">• Before connecting the microinverter to the distribution grid, please contact the local distribution grid company to obtain the appropriate approvals. This connection should only be made by a qualified technician. It is the installer's responsibility to provide an external disconnect switch and overcurrent protection device (OCPD).
<ul style="list-style-type: none">• Only one PV module can be connected to one input of the micro-inverter. Do not connect batteries or other power sources. Microinverters should only be used after observing and applying all technical characteristics.
<ul style="list-style-type: none">• Do not install the device in harsh environments such as flammable, explosive, corrosive, extremely hot or cold, and humid. Do not use the device when the safety device is not working or disabled.
<ul style="list-style-type: none">• Always use personal protective equipment including gloves and goggles when installing.
<ul style="list-style-type: none">• Notify the manufacturer of non-standard installation conditions.
<ul style="list-style-type: none">• Do not use the device if any abnormality is observed during operation. Avoid temporary repairs.
<ul style="list-style-type: none">• All repairs should be performed using only qualified spare parts, which must be installed in accordance with their intended use and by a licensed contractor or authorized service representative.
<ul style="list-style-type: none">• Any liability arising from commercial components rests with their respective manufacturers.
<ul style="list-style-type: none">• Exercise extreme caution whenever the microinverter is disconnected from the public network, as some components may retain enough charge to create an electric shock hazard. Before touching any part of the microinverter, ensure that surfaces and equipment are at a safe touch temperature and voltage potential before proceeding.
<ul style="list-style-type: none">• We are not responsible for damages caused by errors or improper operation.
<ul style="list-style-type: none">• Electrical installation and maintenance should be performed by a licensed electrician and should follow local wiring regulations.

2.2 Symbol Description

Symbol	Usage
	Recycle To comply with European Directive 2002/96/EC on Waste Electrical and Electronic Equipment and its implementation as national law, electrical equipment that has reached the end of its life must be separately collected and returned to an approved recycling facility. Any device no longer required must be returned to an authorized dealer or approved collection and recycling facility.
	Caution Do not come within 8 inches of the microinverter for any length of time while it is in operation.
	Danger of high voltages Danger to life due to high voltage in the microinverter.
	Beware of hot surface The microinverter can become hot while operating. Avoid contact with metal surfaces while operating.
	CE mark The microinverter complies with the requirements of the Low Voltage Directive for the European Union.
	Read manual first Please read the installation manual before installation, operation and maintenance.

2.3 Radio Interference Statement

This microinverter has been tested and found to comply with the limits for CE EMC, which provides reasonable protection against harmful energy. However, if not installed according to the instructions, the microinverter may cause harmful interference to radio equipment. There is no guarantee that such interference will not occur during a particular installation.

To confirm that the radio or television reception is affected by interference from this equipment, turn the equipment off and on to test it. If this equipment causes harmful interference to the radio or television equipment, try to correct the interference through one or more of the following measures

- 1) Relocate the receiving antenna.
- 2) Increase the separation between the microinverter and the receiving antenna.
- 3) Place a shield between the microinverter and the receiving antenna.
- 4) Contact your dealer or an experienced radio/TV technician for help.

3. About Products

3.1 About The 2-in-1 Unit

“2-in-1 cell microinverter” with ultra-wide DC input operating voltage range(22~60 V) and low start-up voltage (22 V only).

The 2-in-1 Micro Inverter WVC-600/WVC-700/WVC-800 is a reliable solution for even-numbered panel photovoltaic systems and provides high CEC weighted efficiency - 92.50% in 2015 (peak efficiency 92.70%).

3.2 Highlights

- The maximum output power can reach 600W/700W/800W.
- Peak efficiency 92.70%. The CEC weighted efficiency is 92.50%.
- Static MPPT efficiency 99.80%. The efficiency of dynamic MPPT on cloudy days is 99.76%.
- Power factor (adjustable) 0.8 lead...0.8 lag.
- External antenna for stronger communication with WiFi sources.
- High reliability: NEMA 3R (IP65) enclosure. 6000 V surge protection.

3.3 Terminals Introduction

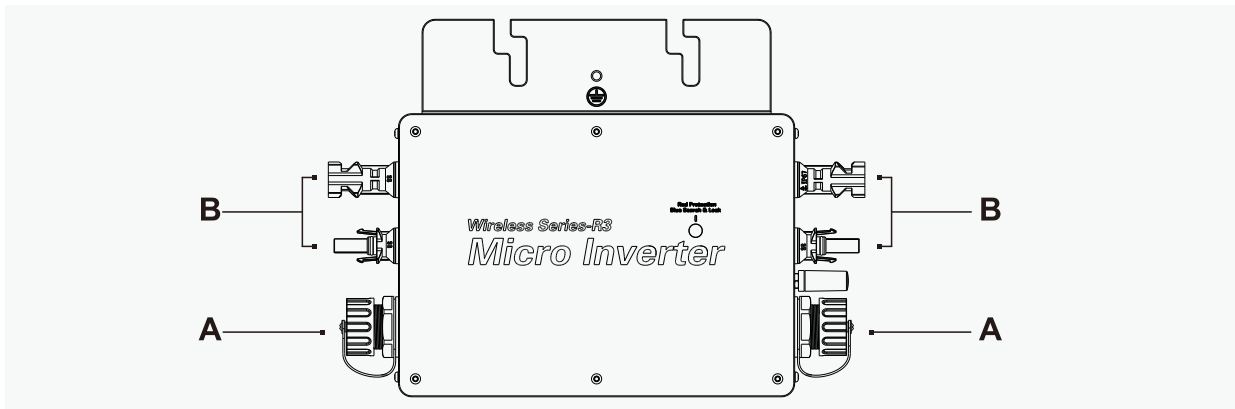

Object	Description
A	AC connector (female)
B	DC connection

3.4 Dimension (mm)

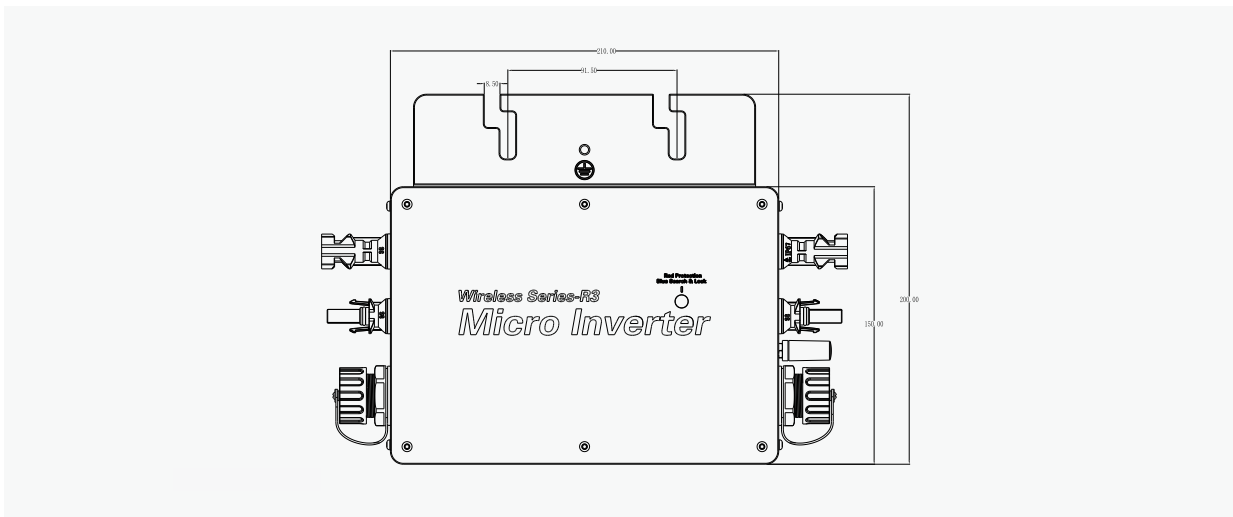

4. About Function

4.1 Work Mode

Normal: In this mode, the micro inverter operates normally, converting DC to AC, supporting household loads and feeding into the public grid.

Zero Output Control: In this mode, the microinverter's power generation is limited based on the current household load, and no additional power goes into the public grid.

Standby: There are several situations where the microinverter will be in standby mode:

- The current situation contradicts the operational requirements of microinverters.
- In zero outlet control mode, no household load or outlet control value is set to "0".

5. About installation

5.1 Accessories

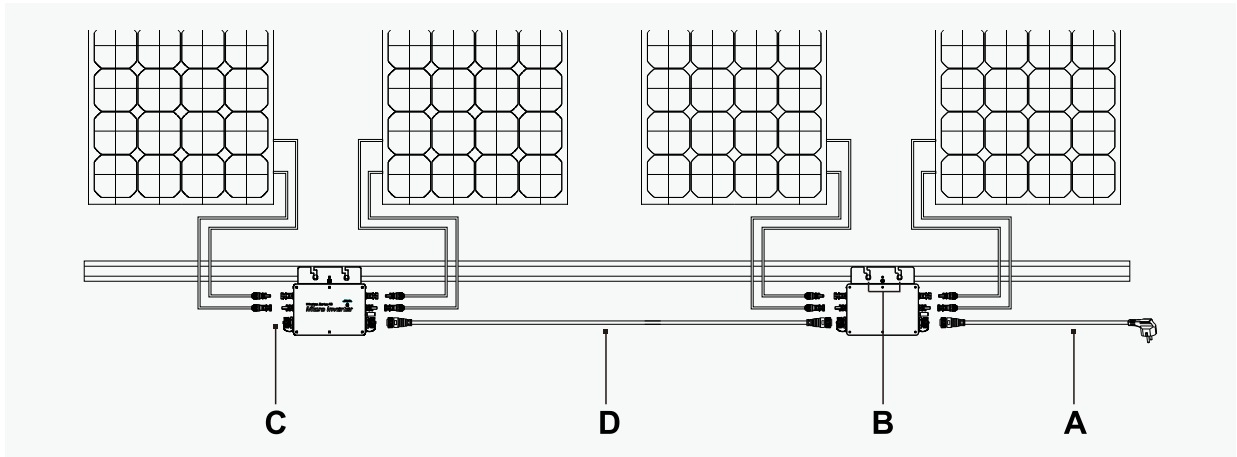

Object	Description
A	AC grid-connected cable (3 meters)
B	8×20mm ² Screws
C	AC female end cap
*D	AC handshake cable

*Note: The AC handshake cable is not included in the accessories and needs to be purchased separately.

5.2 Installation Precautions

Please install the inverter and all DC connectors under the PV modules to avoid rain, snow, UV rays and direct sunlight. Leave at least 5 cm of space around the microinverter housing to ensure ventilation and heat dissipation. *Note: For some countries, local grid regulations (eg UKG98/99) are required.

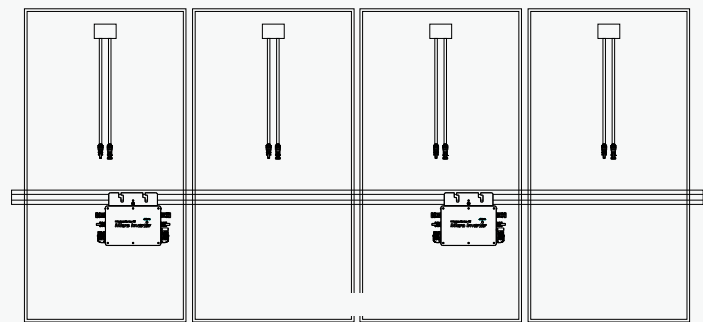

The back of the photovoltaic panel

5.3 Required Space Distance

If the micro-inverter is installed on a concrete roof or steel house on top, their communication with the WIFI router may be slightly affected. Under such installation conditions, the microinverter is best installed 50cm above the roof. Otherwise, it may be necessary to install a WIFI router nearby. The router ensures the quality of communication with the micro-inverter.

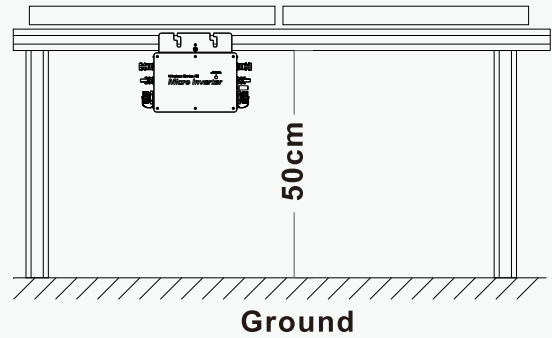

5.4 Grounding Considerations

This microinverter is a Class I device with a basic isolation transformer and this micro inverter must be grounded. There is a ground wire inside the AC cable, so you can usually use this wire directly to ground. If the utility has any special requirements, grounding can be done by attaching the mounting brackets to the rack.

5.5 Preparation

Installation of this equipment is carried out based on the system design and the place in which the equipment is installed.

- Installation must be carried out with the equipment disconnected from the grid (power disconnect switch on) and with the PV modules shaded or isolated.
- Refer to the technical documentation to ensure that the environmental conditions meet the requirements of the micro-inverter (waterproof rating, temperature, etc.)
- To avoid power de-rating due to an increase in the internal temperature of the microinverter, do not expose it to direct sunlight.
- To avoid overheating, always ensure that the airflow around the microinverter is not obstructed.
- Do not install where gas or flammable substances may be present.
- Avoid electromagnetic interference that affects the normal operation of electronic equipment. When choosing an installation location, please observe the following conditions:

- Install only on structures specially designed for PV modules (provided by the installation technician)
- Install the inverter under the PV modules to ensure that it operates in a shaded or shaded environment. If this condition is not met, it may trigger the power drop of the inverter.

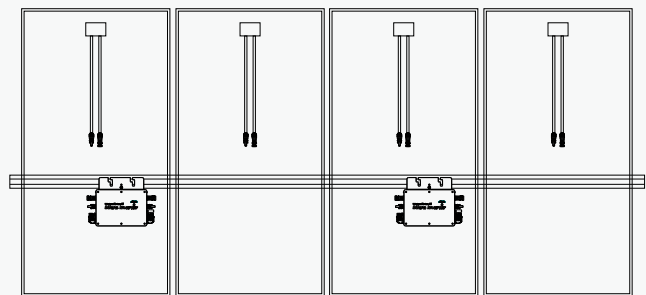

Microinverter installation position

5.6 Installation Steps

Step 1. Mount The Micro Inverter On The Rail

- A) Mark the approximate center of each panel on the frame.
- B) Fasten the screws to the rail.
- C) Hang the micro-inverter on the screw (as shown on the rightshown) and tighten the screws. Silver cover for micro invertersShould face the panel.

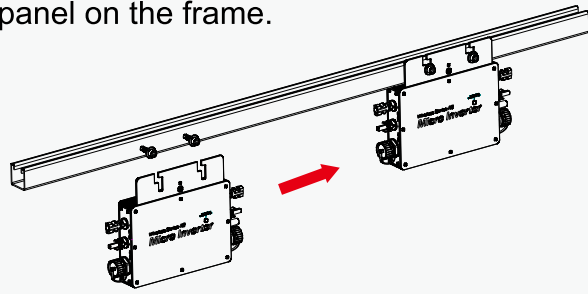

Step 2. AC Cable Connection Method of Micro Inverter

- a) Connect the AC connecting cables to the AC connectors of the two micro-inverters as shown on the right to form a continuous AC branch circuit.

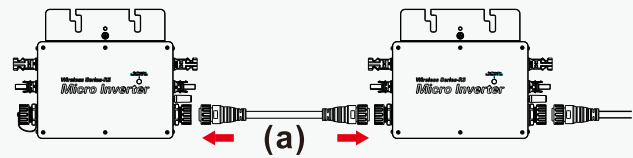

- b) Install the AC end cap on the open AC connector of the last microinverter in the AC branch circuit.

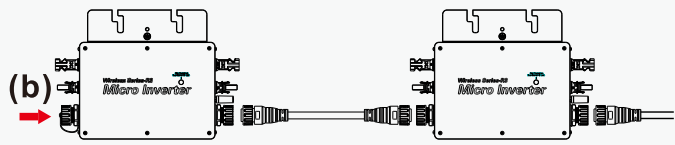

Step 3. Install The Cable

*AC Three-way Handshake Cable Diagram

- A) Components of the AC handshake cable

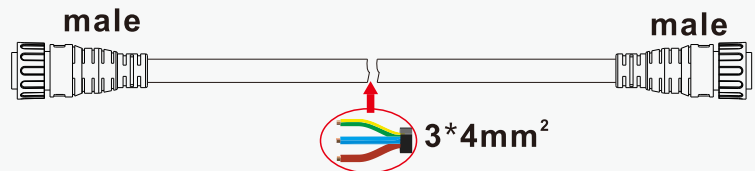

- B) Schematic diagram of the hole position of the male terminal

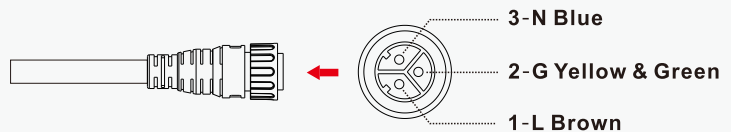

*AC Grid-connected Cable Diagram

- A) Components of the grid-connected cable

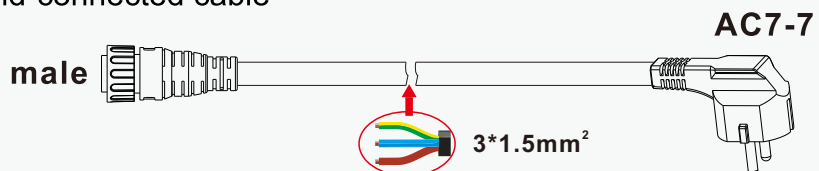

- B) Schematic diagram of female terminal hole position

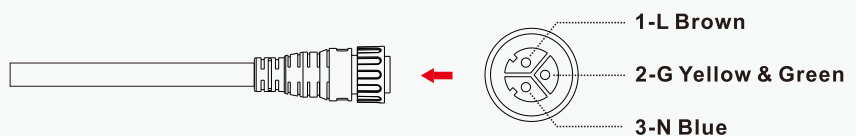

*The maximum number of Ac grid-connected cables is 3 units.

B) Connect the male ends of the handshake cables to the two inverters in the lead to complete the circuit.

C) Connect the other end of the AC end cable to the distribution box and connect it to the local grid.

*In the same branch: @120V max. 6 units;
@230V max.12 units;

*Using the AC grid-connected cable, you can directly plug the cable into the socket for quick grid-connected use, with a maximum number of 3 units.

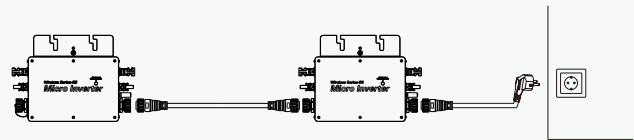
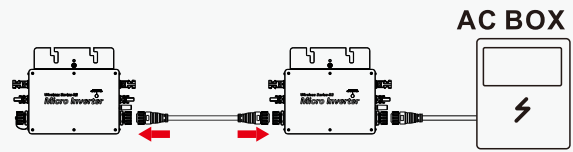

Step 4. Create An Installation Diagram

A) Tear off the QR code on the outer box of the micro inverter(The QR code label style is shown on the right).



B) Paste the QR code label to the corresponding position on the installation drawing.

Micro Inverter Installation Drawing									
Serial Number	Model	Capacity (kW)	Phase	Color	Position	Notes	Remarks	Remarks	Remarks

Step 5. Connect The PV Modules

A) Install the PV modules on the micro inverter above.

B) Connect the DC cables of the PV modules to DC input side of the microinverter.

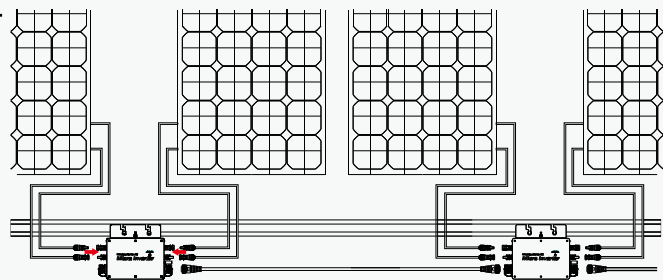

Step 6. Power up the system

- A) Open the AC circuit breaker for the branch circuit.
- B) Open the main AC circuit breaker of the house. Your system will start generating electricity after about a 30s wait time.

Step 7. Set up the monitoring system

Please refer to the Quick Installation Guide of Cloud Intelligent Monitoring Platform to install and set up your monitoring system.

6. Surveillance System

6.1 APP Installation Steps

Bluetooth Mode

1. Open the cloud smart APP and turn on the Bluetooth function of the mobile phone, and then click the "+" icon in the upper right corner of the APP home page to add a device;



Scan QR Code Download "Cloud Intelligence" App

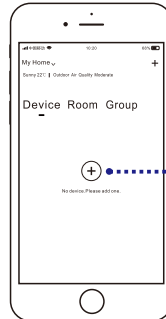

Click to add

2. When the inverter is automatically added on the page, when the inverter appears in the list, click the "+" sign

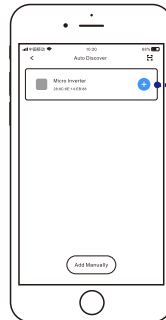

Click to add

3. Select the WiFi signal currently connected to the mobile phone, and enter the WiFi password; click Next

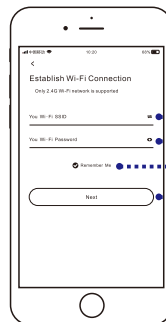

Enter wireless password
Save password
Next

4. The system will enter the network configuration state and wait for the network configuration to be completed.

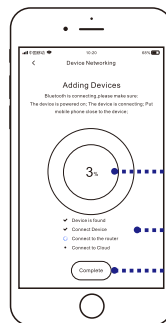

Network Progress
Progress Item
Network Done

Note: Please make sure that the signal from your wireless router can well cover the installation location of the inverter, and make sure that it communicates well with the router. Otherwise, all monitoring APP functions may fail due to poor communication signal.

Wi-Fi Mode

1. If the use of bluetooth fails to configure the network, you can use this method to configure the network, click to scan the QR code to operate



2. Scan the QR code label on the inverter (each device has an independent body code) to activate the distribution network mechanism

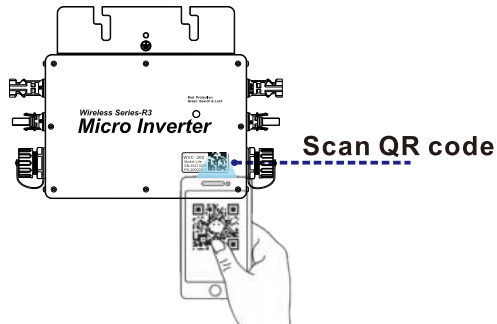

3. Select the WiFi signal currently connected to the mobile phone, and enter the WiFi password; click Next

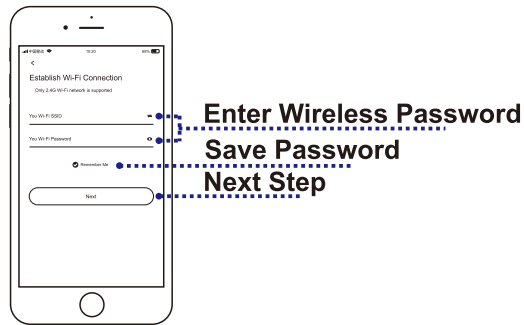

4. The system will enter the network configuration state and wait for the network configuration to be completed.

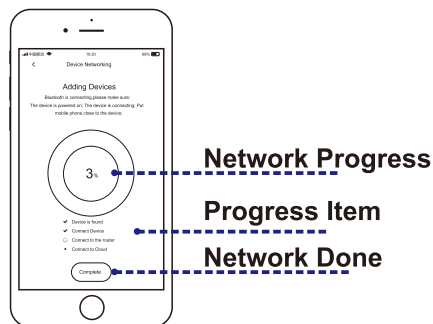



Note: Please make sure that the signal from your wireless router can well cover the installation location of the inverter, and make sure that it communicates well with the router. Otherwise, all monitoring APP functions may fail due to poor communication signal.

6.2 Status LED

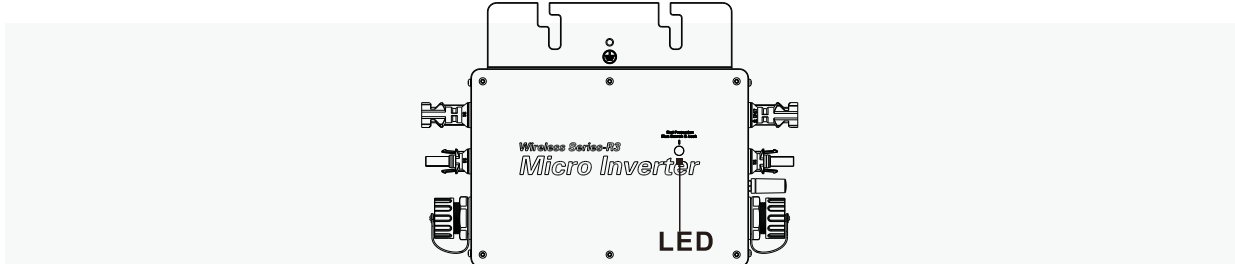
The red LED flashes (3s interval) when WiFi is not configured. When it is detected that the DC voltage and the AC voltage are normal, the startup state is entered.



(1) 	When the inverter has been started and has been connected to the Internet, the status of the LED indicators is as follows
	<ul style="list-style-type: none"> When the inverter is not working: the red light is always on When the inverter is working: the blue light is flashing (MPPT is locked in a long light state)
(2) 	When the inverter is not started and not connected to the grid, the LED indicator status is as follows
	<ul style="list-style-type: none"> When the inverter is not working: the red light flashes When the inverter is in working state: the blue light flashes (MPPT is locked for a long time), the red light flashes (3s interval)
(3) Other status	
	<ul style="list-style-type: none"> When the DC voltage and AC voltage are normal, the red light is on/off: the inverter is damaged.
*Note: For more information, please refer to Cloud Intelligent Monitoring Platform.	

6.3 Insulation Resistance Detection

There is a resistance sensor in the microinverter that measures the resistance between the output of the PV module and ground. If there is a problem with the insulation of the PV module, the DC wiring of the module or the connector, etc., it may cause the resistance between the module output and the ground to decrease.

If this resistance falls below a preset threshold, the microinverter will stop generating electricity and report this ground fault. This fault will continue until cleared on the cloud intelligent monitoring platform. The fault will continue until the micro-inverter restarts.

Note that this failure cannot be cleared if the cause of the failure still exists. If the fault persists, Please contact your salesperson for a solution.







6.4 On-site Inspection (Qualified Installers Only)

To troubleshoot an inoperable microinverter, follow the steps below.

1	Verify that the mains voltage and frequency are within the ranges shown in this microinverter technical data appendix.
2	Check the connection to the utility grid. Verify that utility power is present on the associated microinverter by disconnecting AC power, then DC power. Never disconnect the AC cable while the microinverter is working. Reconnect the DC module connector and watch the LED blink five times.
3	Check the AC branch circuits between all inverters and that each inverter is powered by the utility grid, as in the previous step.
4	Make sure all AC circuit breakers are working and closed.
5	Check the DC connection between the microinverter and the PV modules.
6	Verify that the PV module DC voltage is within the allowable range shown in the technical data appendix of this manual.
7	If the problem persists, please call Customer Support.
	Don't try to repair the microinverter. If troubleshooting fails, return it to the factory for replacement.

6.5 Routine Maintenance

1. Only authorized personnel are allowed to perform maintenance operations, and authorized personnel are responsible for reporting any abnormal conditions.
2. When performing maintenance, always use the personal protective equipment provided by your employer.
3. During normal operation, check that the environmental and logistical conditions are correct. Make sure that these conditions have not changed over time and that the equipment has not been exposed to severe weather conditions and not covered by foreign objects.
4. Do not use it if you find a problem, and restore it to the original state after the problem is solved.
5. Carry out annual inspection of each component, and use a vacuum cleaner or special brush to clean the equipment.

	Do not attempt to disassemble the inverter or perform any internal repairs! Unauthorized private repairs will void your warranty.
	The AC output harness (AC breakout cable on the microinverter) cannot be replaced. If the power cord is damaged, the device should be scrapped.
	Unless otherwise specified, maintenance operations must be performed with all connections to the AC side and DC side of the inverter disconnected.
	When cleaning, do not use wipes made of filamentous materials or corrosive products that may corrode equipment parts or generate static charges.
	Avoid temporary repairs. All repairs should be carried out using only original spare parts.
	A 40 A circuit breaker should be provided for each branch circuit, but no central protection unit is required.

6.6 Micro Inverter Replacement

a. How to disassemble the microinverter:
<ul style="list-style-type: none">• Disconnect power from the AC branch circuit breaker.
<ul style="list-style-type: none">• Remove the PV panel from the bracket and cover the panel.
<ul style="list-style-type: none">• Use a meter to measure and make sure there is no current flowing in the DC wires between the panel and the microinverter.
<ul style="list-style-type: none">• Use the DC disconnect tool to remove the DC connector.
<ul style="list-style-type: none">• Use the AC disconnect tool to remove the AC connector.
<ul style="list-style-type: none">• Unscrew the fixing screws on the top of the micro-inverter and remove the micro-inverter from the PV support.
b. How to replace the microinverter:
<ul style="list-style-type: none">• Please note the SN of the new microinverter.
<ul style="list-style-type: none">• Make sure the AC branch circuit breaker is turned off, then follow the microinverter installation steps to install the replacement unit.
<ul style="list-style-type: none">• Enter the monitoring platform (if the customer has already registered the site online), enter the "Device" page, and re-add a new device according to the conventional method of adding an inverter to complete the replacement.

7. Retired

7.1 Retired

Disconnect the microinverter from the DC input and AC output. Remove all connecting cables from the micro inverter. Remove the microinverter from the frame.

Pack the micro-inverter in its original packaging, or use a 5kg carton that can be completely closed if the original packaging is no longer available.

7.2 Storage And Transportation

Uses suitable means to package and protect individual components for easy shipping and subsequent handling. Transportation of equipment, especially by road, must be carried out in a manner suitable for protecting components, especially electronic components, from violence, shock, moisture, vibration, etc. Properly dispose of packaged components to avoid accidental injury.

It is the customer's responsibility to check the condition of the shipping parts. After receiving the micro inverter, it is necessary to inspect the container for any external damage and confirm receipt of all items. If damage or missing components are detected, please call the delivery carrier immediately. If inspection reveals damage to the micro inverter, please contact the supplier or authorized distributor for a repair/return decision and instructions on the process.

Micro inverter storage temperature from -20°C to 50°C

7.3 Deal With

- If the device is not for immediate use or long-term storage, make sure it is properly packaged. Equipment must be stored in a well-ventilated inner area that does not have characteristics that could damage equipment components.
- A full inspection should be carried out when restarting after a prolonged or prolonged cessation of use.
- For end-of-life equipment that may be hazardous to the environment, properly dispose of the equipment in accordance with the regulations in force in the country where it is installed.

8. Technical data

	Warning: Be sure to verify the following before installing a Microinverter system.
	Verify that the voltage and current specifications of the PV modules match those of the microinverter.
	The maximum open circuit voltage rating of the PV modules must be within the operating voltage range of the microinverter.
	It is recommended that the maximum rated current of the MPPT \leq the maximum input DC current. But the maximum short-circuit current must be less than or equal to the maximum input DC short-circuit current.
	The output DC power of photovoltaic modules is not recommended to exceed 1.35 times the output AC power of the micro-inverter.

8.1 DC Input

Model	WVC-600	WVC-700	WVC-800
Common module power (W)	Max 2×375W	Max 2×435W	Max 2×500W
Peak Power MPPT Voltage Range (V)	30-60		
Start-up voltage (V)	22		
Operating Voltage Range (V)	22-60		
Maximum input voltage (V)	60		
Maximum input current (A)	2×14	2×16	2×18
Maximum input short-circuit current (A)	2×16	2×18	2×20
Maximum backfeed current to array (A)	0		

8.2 AC Output

Model	WVC-600	WVC-700	WVC-800
Rated output power (VA)	600	700	800
Rated output current (A)	@120V 5A @230V 2.6A	@120V 5.9A @230V 3.1A	@120V 6.6A @230V 3.5A
Nominal Output Voltage/Range (V)	@120V 85-160VAC @230V 180-265VAC		
Nominal Frequency/Range (Hz)	@120V 48-51Hz/58-61Hz @230V 48-51Hz/58-61Hz		
power factor	> 0.99 default 0.8 leading...0.8 lagging		
Output current harmonic distortion	<3%		
Maximum unit per branch	@120V 6 PCs @230V 12Pcs	@120V 6 PCs @230V 12Pcs	@120V 6 PCs @230V 12Pcs

8.3 Efficiency, Safety and Protection

Model	WVC-600	WVC-700	WVC-800
Peak Microinverter Efficiency	92.70%		
CEC weighted efficiency	92.50%		
Nominal MPPT Efficiency	99.80%		
Night power consumption (mW)	<50		

8.4 Mechanical Data

Model	WVC-600	WVC-700	WVC-800
Ambient temperature range (°C)	-20 to +50		
Storage temperature range (°C)	-20 to +50		
Dimensions (L×W×H mm)	283×200×41.6		
Weight (kg)	1.46		
Waterproof level	Outdoor Nema 3r (ip65)		
Cooling method	Natural Convection (no Fans)		
Degree of pollution	PD3		

8.5 Feature

Model	WVC-600	WVC-700	WVC-800
Power Delivery Mode	Reverse transmission, load priority		
Communication method	WiFi		
Surveillance system	Cloud Intelligence		
Warranty	5 years		
Electrical Standard	EN 50549-1:2019, EN 50549-2:2019 EN 61000-6-1:2007, EN 61000-6-3:2007 + A1:2011 + AC2012 IEC/EN 62109-1:2010, IEC/EN 62109-2:2011		

*Note: Voltage and frequency ranges may exceed nominal values if required by the utility company.

8.6 Package

Specification	Single (packaging)	FCL (5units)
Standard 3m AC grid-connected cable	2.3Kg	12.3Kg
	345×240×100mm	450×400×260mm
Standard 5m AC grid-connected cable	2.6Kg	13.8Kg
	345×240×100mm	450×400×260mm

Specification	Single (packaging)	FCL (6units)
Standard 3m AC grid-connected cable	2.45Kg	15.6Kg
	345×245×110mm	510×350×365mm
Standard 5m AC grid-connected cable	2.75Kg	17.4Kg
	345×245×110mm	510×350×365mm

Appendix 1: Instructions

Micro Inverter Installation Drawing										
North 	Panel Type: Azimuth: Tilt: Sheet _____				Customer Information:			Serial Number:		
Array	1	2	3	4	5	6	7	8	9	10
A										
B										
C										
D										
E										

Appendix 2: Wiring Diagram @230 VAC Single Phase:

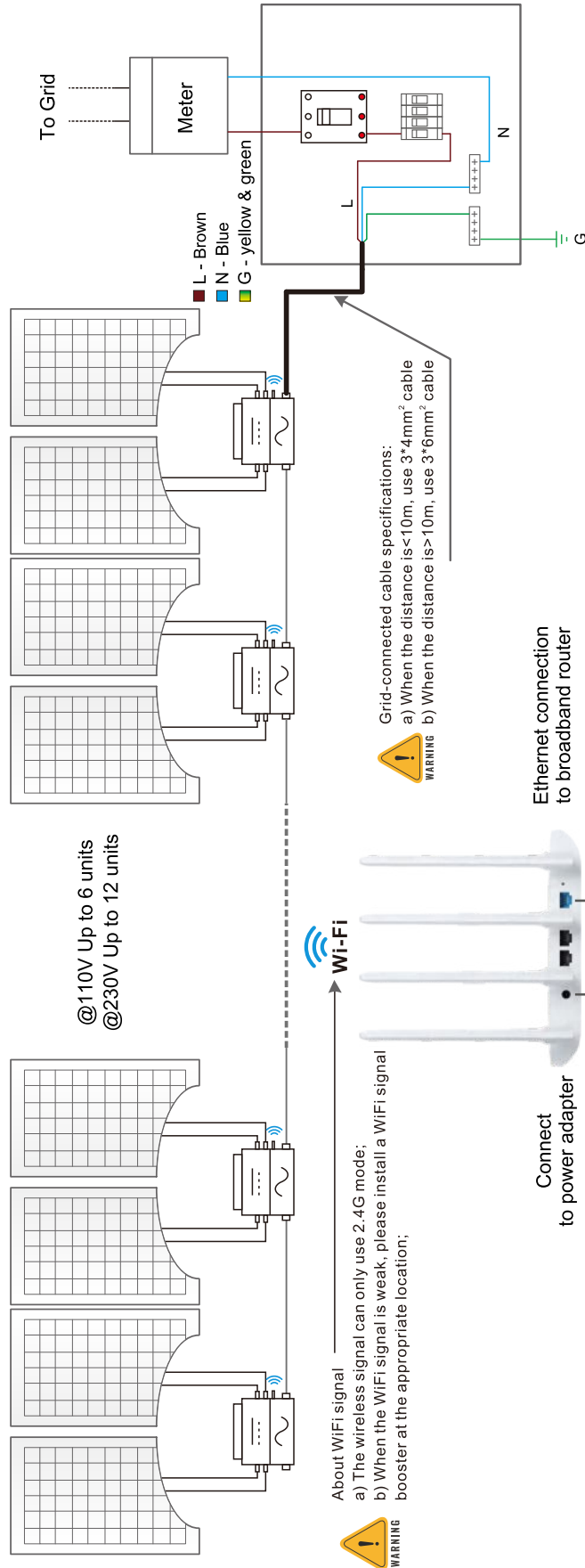

Wiring Diagram @230 VAC 3 Phase:

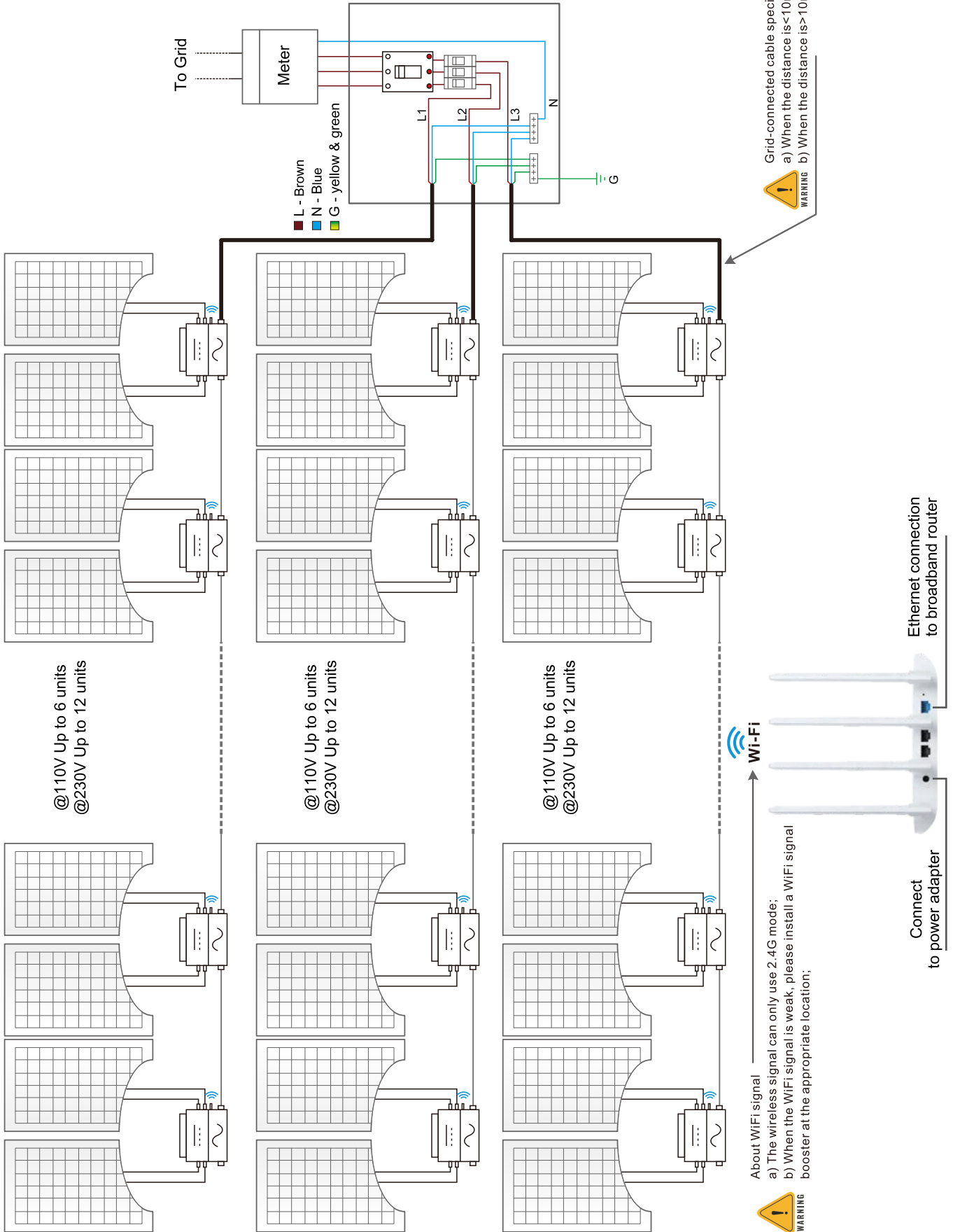

Wiring Diagram

@120 VAC / 240 VAC Split Phase:

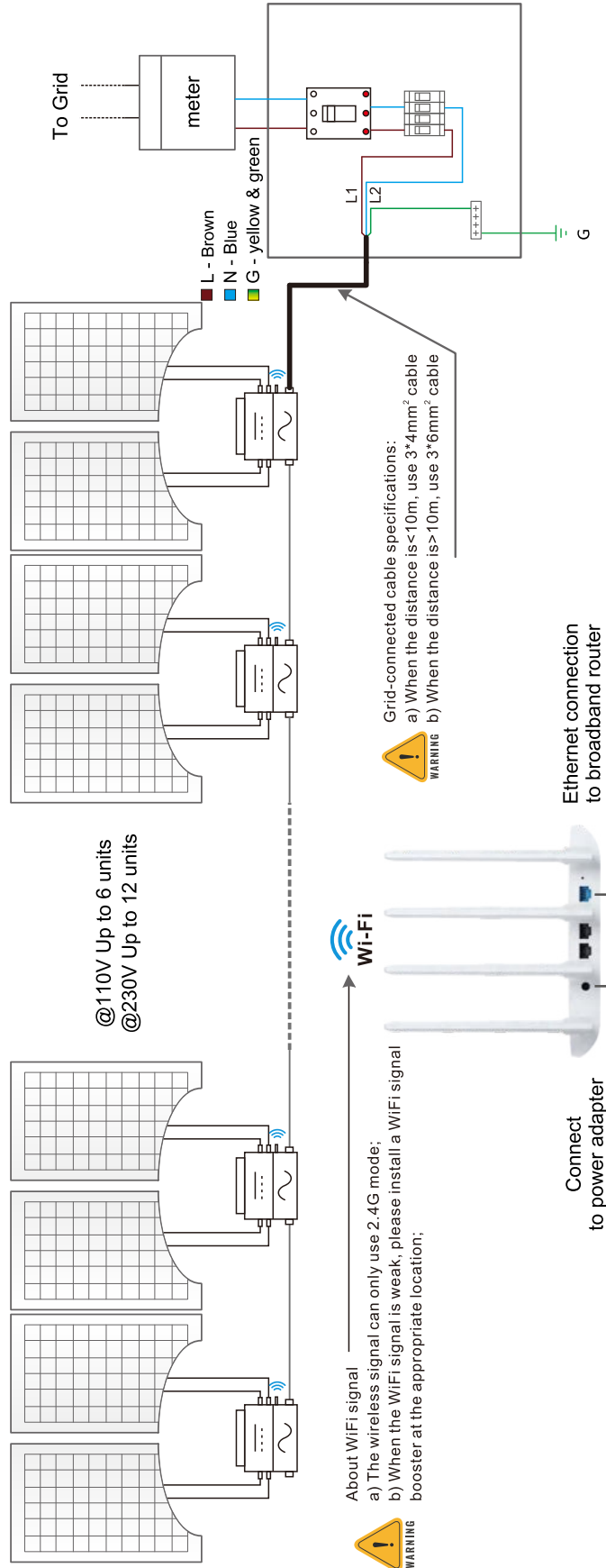

Wiring Diagram @120 VAC / 208 VAC 3 Phase:

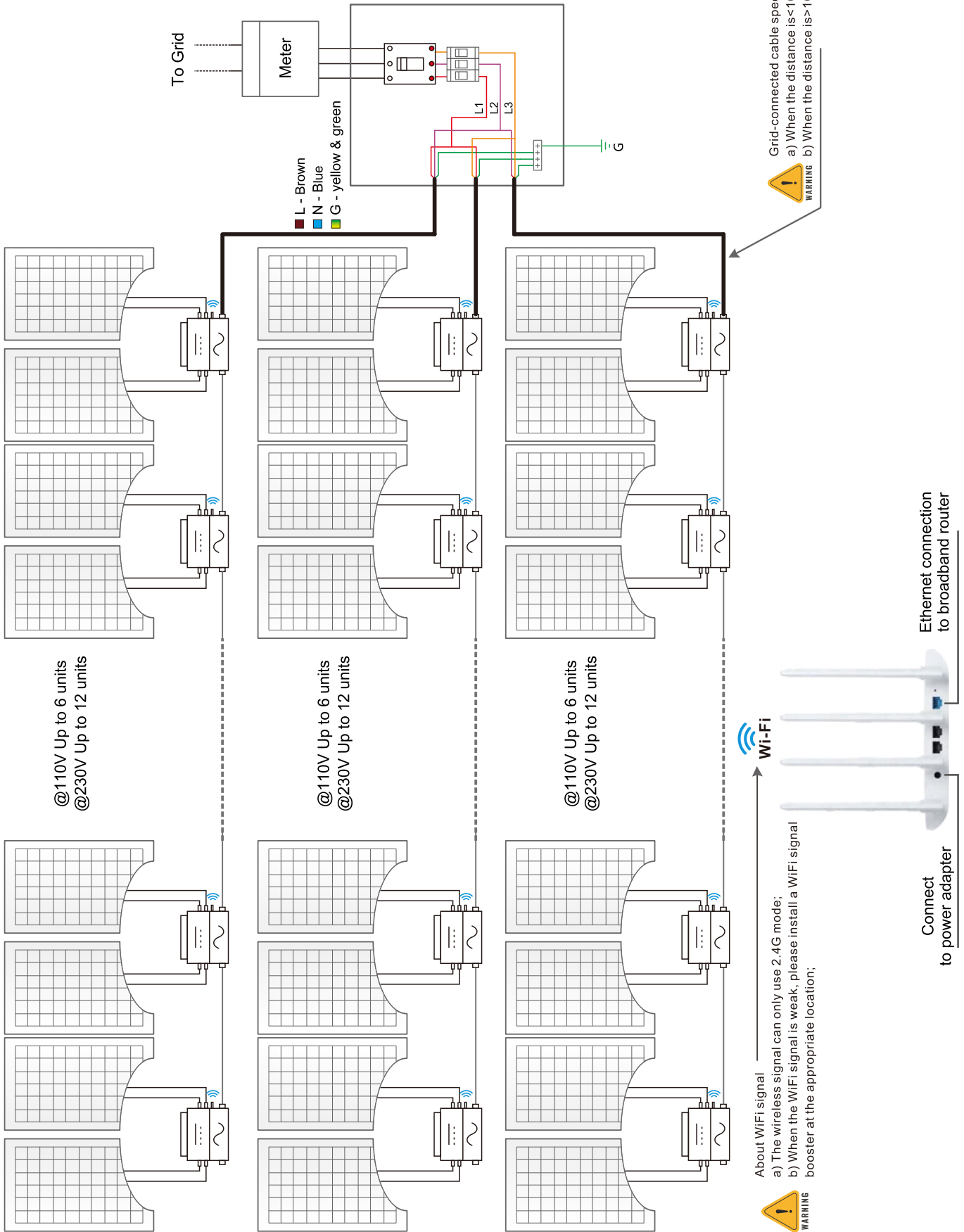

Grid-connected cable specifications:
 a) When the distance is <10m, use 3*4mm² cable
 b) When the distance is >10m, use 3*6mm² cable

WARNING

About WiFi signal
 a) The wireless signal can only use 2.4G mode;
 b) When the WiFi signal is weak, please install a WiFi signal booster at the appropriate location;